

Features

Plug-in mount 10 A General purpose relay

- 2 & 3 pole changeover contacts
- Cadmium Free contacts (preferred version)
- AC coils & DC coils
- UL Listing (certain relay/socket combinations)
- Contact material options
- Lockable test button with mechanical flag indicator (preferred version)
- 90 series sockets
- Coil EMC suppression
- Timer accessories 86 series

60.12



- 2 pole, 10 A power contacts
- 8 pin plug-in

60.13



- 3 pole, 10 A power contacts
- 11 pin plug-in

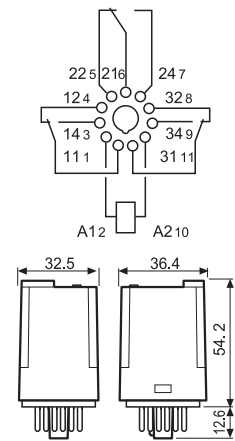
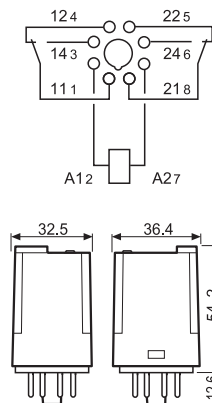

FOR UL HORSEPOWER AND PILOT DUTY RATINGS
SEE "General technical information" page V

Contact specification		60.12	60.13
Contact configuration		2 CO (DPDT)	3 CO (3PDT)
Rated current/Maximum peak current	A	10/20	10/20
Rated voltage/Maximum switching voltage	V AC	250/400	250/400
Rated load AC1	VA	2,500	2,500
Rated load AC15 (230 V AC)	VA	500	500
Single phase motor rating (230 V AC)	kW	0.37	0.37
Breaking capacity DC1: 30/110/220 V	A	10/0.4/0.15	10/0.4/0.15
Minimum switching load	mW (V/mA)	500 (10/5)	500 (10/5)
Standard contact material		AgNi	AgNi
Coil specification		60.12	60.13
Nominal voltage (U _N)	V AC (50/60 Hz)	6 - 12 - 24 - 48 - 60 - 110 - 120 - 230 - 240 - 400	
	V DC	6 - 12 - 24 - 48 - 60 - 110 - 125 - 220	
Rated power AC/DC	VA (50 Hz)/W	2.2/1.3	2.2/1.3
Operating range	AC	(0.8...1.1)U _N	(0.8...1.1)U _N
	DC	(0.8...1.1)U _N	(0.8...1.1)U _N
Holding voltage	AC/DC	0.8 U _N /0.5 U _N	0.8 U _N /0.5 U _N
Must drop-out voltage	AC/DC	0.2 U _N /0.1 U _N	0.2 U _N /0.1 U _N
Technical data		60.12	60.13
Mechanical life AC/DC	cycles	20 · 10 ⁶ /50 · 10 ⁶	20 · 10 ⁶ /50 · 10 ⁶
Electrical life at rated load AC1	cycles	200 · 10 ³	200 · 10 ³
Operate/release time	ms	9/9	9/9
Insulation between coil and contacts (1.2/50 μs)	kV	4	3.6
Dielectric strength between open contacts	V AC	1,000	1,000
Ambient temperature range	°C	-40...+70	-40...+70
Environmental protection		RT I	RT I

Approvals (according to type)



Features

Plug-in mount - 6 A

Bifurcated contacts for low level switching

- 2 & 3 pole changeover contacts
- Cadmium Free contacts (Gold plated Silver Nickel)
- AC coils & DC coils
- Lockable test button with mechanical flag indicator (preferred version)
- 90 series sockets
- Coil EMC suppression
- Timer accessories 86 series

60.12 - 5200



- 2 pole, 6 A bifurcated contacts
- 8 pin plug-in

60.13 - 5200



- 3 pole, 6 A bifurcated contacts
- 11 pin plug-in

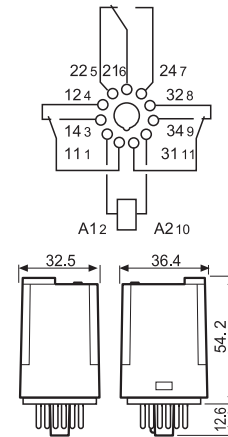
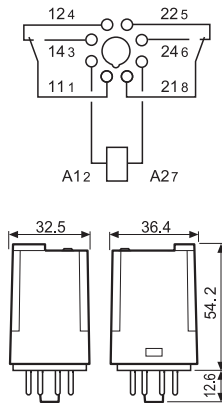

FOR UL HORSEPOWER AND PILOT DUTY RATINGS
SEE "General technical information" page V

Contact specification			
Contact configuration		2 CO (DPDT)	3 CO (3PDT)
Rated current/Maximum peak current	A	6/10	6/10
Rated voltage/Maximum switching voltage	V AC	250/400	250/400
Rated load AC1	VA	1,500	1,500
Rated load AC15 (230 V AC)	VA	250	250
Single phase motor rating (230 V AC)	kW	0.185	0.185
Breaking capacity DC1: 30/110/220 V	A	6/0.3/0.12	6/0.3/0.12
Minimum switching load	mW (V/mA)	50 (5/5)	50 (5/5)
Standard contact material		AgNi + Au (5 µm) bifurcated contacts	AgNi + Au (5 µm) bifurcated contacts
Coil specification			
Nominal voltage (U _N)	V AC (50/60 Hz)	6 - 12 - 24 - 48 - 60 - 110 - 120 - 230 - 240 - 400	
	V DC	6 - 12 - 24 - 48 - 60 - 110 - 125 - 220	
Rated power AC/DC	VA (50 Hz)/W	2.2/1.3	2.2/1.3
Operating range	AC	(0.8...1.1)U _N	(0.8...1.1)U _N
	DC	(0.8...1.1)U _N	(0.8...1.1)U _N
Holding voltage	AC/DC	0.8 U _N /0.5 U _N	0.8 U _N /0.5 U _N
Must drop-out voltage	AC/DC	0.2 U _N /0.1 U _N	0.2 U _N /0.1 U _N
Technical data			
Mechanical life AC/DC	cycles	20 · 10 ⁶ /50 · 10 ⁶	20 · 10 ⁶ /50 · 10 ⁶
Electrical life at rated load AC1	cycles	250 · 10 ³	250 · 10 ³
Operate/release time	ms	9/9	9/9
Insulation between coil and contacts (1.2/50 µs)	kV	4	3.6
Dielectric strength between open contacts	V AC	1,000	1,000
Ambient temperature range	°C	-40...+70	-40...+70
Environmental protection		RT I	RT I

Approvals (according to type)



Features

Flange mount - General purpose relay 10 A

- Faston 187, 4.8x0.8 mm
- 2 & 3 pole changeover contacts
- AC coils & DC coils
- Cadmium Free contacts (preferred version)
- Contacts material options

60.62



- 2 pole, 10 A power contacts
- Flange mount/Faston 187

60.63



- 3 pole, 10 A power contacts
- Flange mount/Faston 187

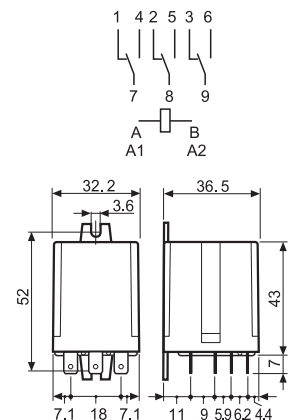
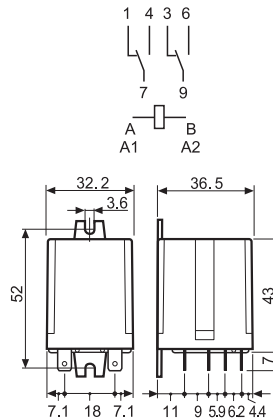

FOR UL HORSEPOWER AND PILOT DUTY RATINGS
SEE "General technical information" page V

Contact specification		60.62	60.63
Contact configuration		2 CO (DPDT)	3 CO (3PDT)
Rated current/Maximum peak current	A	10/20	10/20
Rated voltage/Maximum switching voltage	V AC	250/400	250/400
Rated load AC1	VA	2,500	2,500
Rated load AC15 (230 V AC)	VA	500	500
Single phase motor rating (230 V AC)	kW	0.37	0.37
Breaking capacity DC1: 30/110/220 V	A	10/0.4/0.15	10/0.4/0.15
Minimum switching load	mW (V/mA)	500 (10/5)	500 (10/5)
Standard contact material		AgNi	AgNi
Coil specification		60.62	60.63
Nominal voltage (U _N)	V AC (50/60 Hz)	6 - 12 - 24 - 48 - 60 - 110 - 120 - 230 - 240 - 400	
	V DC	6 - 12 - 24 - 48 - 60 - 110 - 125 - 220	
Rated power AC/DC	VA (50 Hz)/W	2.2/1.3	2.2/1.3
Operating range	AC	(0.8...1.1)U _N	(0.8...1.1)U _N
	DC	(0.8...1.1)U _N	(0.8...1.1)U _N
Holding voltage	AC/DC	0.8 U _N /0.5 U _N	0.8 U _N /0.5 U _N
Must drop-out voltage	AC/DC	0.2 U _N /0.1 U _N	0.2 U _N /0.1 U _N
Technical data		60.62	60.63
Mechanical life AC/DC	cycles	20 · 10 ⁶ /50 · 10 ⁶	20 · 10 ⁶ /50 · 10 ⁶
Electrical life at rated load AC1	cycles	200 · 10 ³	200 · 10 ³
Operate/release time	ms	9/9	9/9
Insulation between coil and contacts (1.2/50 μs)	kV	4	3.6
Dielectric strength between open contacts	V AC	1,000	1,000
Ambient temperature range	°C	-40...+70	-40...+70
Environmental protection		RT I	RT I

Approvals (according to type)



Ordering information

Example: 60 series plug-in relay, 3 CO (3PDT), 12 V DC coil, test button and mechanical indicator.

6	0	.	1	3	.	9	.	0	1	2	.	0	0	A	B	C	D	4	0
----------	----------	---	----------	----------	---	----------	---	----------	----------	----------	---	----------	----------	----------	----------	----------	----------	----------	----------

Series ————

Type ————

1 = 8/11 pin plug-in
6 = Faston 187 (4.8x0.8 mm) with flange mount

No. of poles ————

2 = 2 pole
3 = 3 pole

Coil version ————

4 = Current sensing (60.12/13 only)
8 = AC (50/60 Hz)
9 = DC

Coil voltage ————

See coil specifications

A: Contact material
0 = Standard
2 = AgCdO
5 = AgNi + Au (5 µm)

B: Contact circuit
0 = CO (nPDT)
2 = Bifurcated contacts
60.12/13 - 6 A only

D: Special versions
0 = Standard

C: Options
0 = None
2 = Mechanical indicator
3 = LED (AC)
4 = Lockable test button + mechanical indicator
5* = Lockable test button + LED (AC)
54* = Lockable test button + LED (AC) + mechanical indicator
6* = LED + diode (DC, polarity positive to pin 2)
7* = Lockable test button + LED + diode (DC, polarity positive to pin 2)
74* = Lockable test button + LED + diode (DC, polarity positive to pin 2) + mechanical indicator

* Options not available for 220 V DC and 400 V AC versions.

Selecting features and options: only combinations in the same row are possible.
Preferred selections for best availability are shown in **bold**.

Type	Coil version	A	B	C	D
60.12/13	AC	0 - 2	0	0 - 2 - 3 - 4 - 5	0
	AC	0 - 2	0	54	/
	AC	5	0 - 2	0 - 2 - 3 - 4 - 5	0
	AC	5	0 - 2	54	/
	DC	0 - 2	0	0 - 2 - 4 - 6 - 7	0
	DC	0 - 2	0	74	/
	DC	5	0 - 2	0 - 2 - 4 - 6 - 7	0
	DC	5	0 - 2	74	/
	current sensing	0	0	4	0
60.62/63	AC-DC	0 - 2 - 5	0	0	0

Descriptions: Options and Special versions

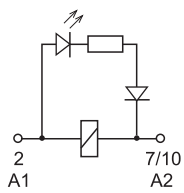

C: Option 3, 5, 54
LED (AC)

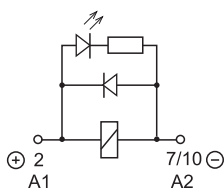

C: Option 6, 7, 74
LED + diode (DC, polarity positive to pin 2)



Lockable test button and mechanical flag indicator (0040, 0050, 0054, 0070, 0074)

The dual-purpose Finder test button can be used in two ways:

Case 1) The plastic pip (located directly above the test button) remains intact. In this case, when the test button is pushed, the contacts operate. When the test button is released the contacts return to their former state.

Case 2) The plastic pip is broken-off (using an appropriate cutting tool). In this case, (in addition to the above function), when the test button is pushed and rotated, the contacts are latched in the operating state, and remain so until the test button is rotated back to its former position. In both cases ensure that the test button actuation is swift and decisive.

Technical data

Insulation according to EN 61810-1		2 pole		3 pole	
Nominal voltage of supply system	V AC	230/400		230/400	
Rated insulation voltage	V AC	250	400	250	400
Pollution degree		3	2	3	2
Insulation between coil and contact set					
Type of insulation		Basic		Basic	
Overtoltage category		III		III	
Rated impulse voltage	kV (1.2/50 μ s)	4		3.6	
Dielectric strength	V AC	2,000		2,000	
Insulation between adjacent contacts					
Type of insulation		Basic		Basic	
Overtoltage category		III		III	
Rated impulse voltage	kV (1.2/50 μ s)	4		3.6	
Dielectric strength	V AC	2,000		2,000	
Insulation between open contacts					
Type of disconnection		Micro-disconnection		Micro-disconnection	
Dielectric strength	V AC/kV (1.2/50 μ s)	1,000/1.5		1,000/1.5	
Conducted disturbance immunity					
Burst (5...50)ns, 5 kHz, on A1 - A2		EN 61000-4-4		level 4 (4 kV)	
Surge (1.2/50 μ s) on A1 - A2 (differential mode)		EN 61000-4-5		level 4 (4 kV)	
Other data					
Bounce time: NO/NC	ms	2/4			
Vibration resistance (5...55)Hz: NO/NC	g	22/22			
Shock resistance	g	20			
Power lost to the environment	without contact current	W	1.3	1.3	
	with rated current	W	2.7 (60.12, 60.62)	3.4 (60.13, 60.63)	

Contact specification

F 60 - Electrical life (AC) v contact current

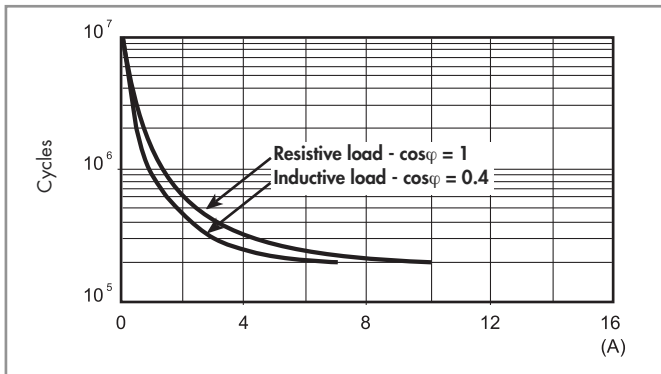

H 60 - Maximum DC1 breaking capacity

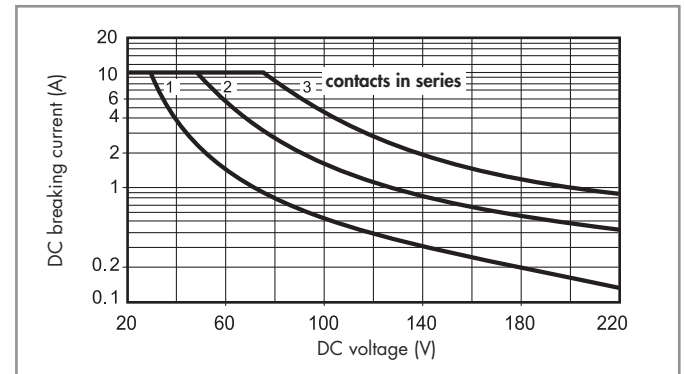

- When switching a resistive load (DC1) having voltage and current values under the curve, an electrical life of $\geq 100 \cdot 10^3$ can be expected.
 - In the case of DC13 loads, the connection of a diode in parallel with the load will permit a similar electrical life as for a DC1 load.
- Note: the release time for the load will be increased.

Coil specifications

DC coil data

Nominal voltage U_N V	Coil code	Operating range		Resistance R Ω	Rated coil consumption I at U_N mA
		U_{min} V	U_{max} V		
6	9.006	4.8	6.6	28	214
12	9.012	9.6	13.2	110	109
24	9.024	19.2	26.4	445	53.9
48	9.048	38.4	52.8	1,770	27.1
60	9.060	48	66	2,760	21.7
110	9.110	88	121	9,420	11.7
125	9.125	100	138	12,000	10.4
220	9.220	176	242	37,300	5.8

AC coil data

Nominal voltage U_N V	Coil code	Operating range		Resistance R Ω	Rated coil consumption I at U_N (50Hz) mA
		U_{min} V	U_{max} V		
6	8.006	4.8	6.6	4.6	367
12	8.012	9.6	13.2	19	183
24	8.024	19.2	26.4	74	90
48	8.048	38.4	52.8	290	47
60	8.060	48	66	450	37
110	8.110	88	121	1,600	20
120	8.120	96	132	1,940	18.6
230	8.230	184	253	7,250	10.5
240	8.240	192	264	8,500	9.2
400	8.400	320	440	19,800	6

Coil specifications

R 60 - DC coil operating range v ambient temperature

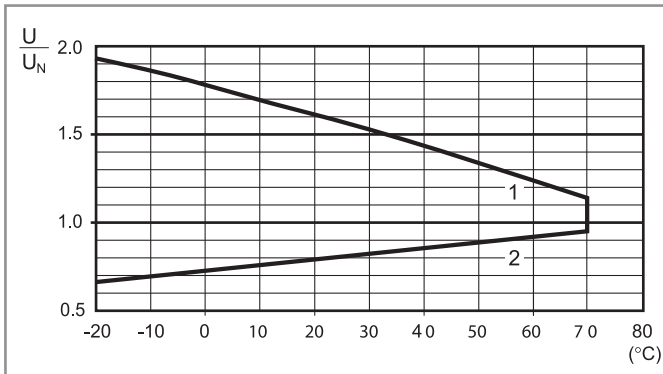

- 1 - Max. permitted coil voltage.
- 2 - Min. pick-up voltage with coil at ambient temperature.

R 60 - AC coil operating range v ambient temperature

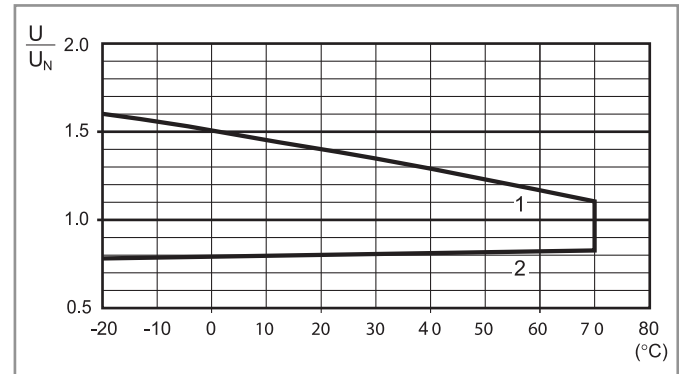

- 1 - Max. permitted coil voltage.
- 2 - Min. pick-up voltage with coil at ambient temperature.

Current sensing version

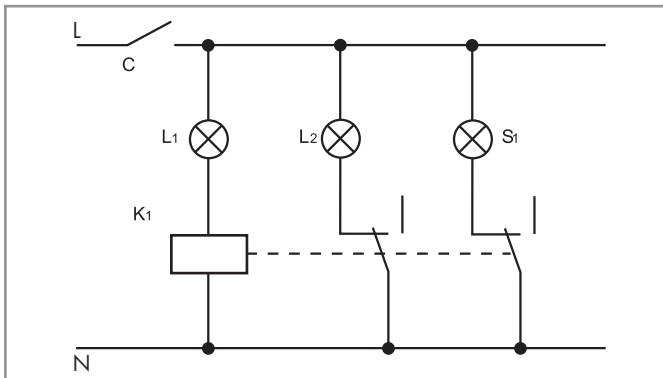

Typical application with current sensing relays.
An open circuit filament of lamp L1 is detected by the current sensing relay coil (K1) which causes the back-up safety lamp L2 to be energised, and indication of failure at the control panel via lamp S1.

Example: navigation light.

- L1 = Light
- L2 = Safety light
- S1 = Control light
- K1 = Relay

Current sensing DC coil data

Coil code	I_{min} (A)	I_N (A)	I_{max} (A)	R (Ω)
4202	1.7	2.0	2.4	0.15
4182	1.5	1.8	2.2	0.19
4162	1.4	1.6	1.9	0.24
4142	1.2	1.4	1.7	0.31
4122	1.0	1.2	1.4	0.42
4102	0.85	1.0	1.2	0.61
4092	0.8	0.9	1.1	0.75
4062	0.5	0.6	0.7	1.70
4032	0.25	0.3	0.4	6.70
4012	0.085	0.1	0.15	61

Current sensing AC coil data

Coil code	I_{min} (A)	I_N (A)	I_{max} (A)	R (Ω)
4251	2.1	2.5	3.0	0.05
4181	1.5	1.8	2.2	0.10
4161	1.4	1.6	1.9	0.12
4121	1.0	1.2	1.4	0.22
4101	0.85	1.0	1.2	0.32
4051	0.42	0.5	0.6	1.28
4041	0.34	0.4	0.5	2.00
4031	0.25	0.3	0.4	3.57
4021	0.17	0.2	0.25	8.0
4011	0.085	0.1	0.15	32.1

Other types of current sensing relays are available on request.

Accessories

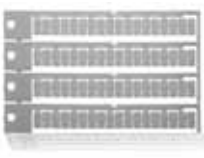

060.72

Sheet of marker tags for relay types 60.12 and 60.13, plastic, 72 tags, 6x12 mm

060.72